

CDA-4D

Installation Instructions

Bowers & Wilkins



ENGLISH

Bowers & Wilkins will not be held responsible for any damage or injury caused by insecure installation. Installation must be carried out in accordance with national building and wiring regulations.

FRANÇAIS

Bowers & Wilkins ne pourra être tenu responsable de tout dommages ou blessures causés par une installation non sécurisée. La pose doit être effectuée conformément aux réglementations nationales en matière de construction et de câblage.

ESPAÑOL

Bowers & Wilkins no se hará responsable de ningún daño o lesión causado por una instalación insegura. La instalación debe llevarse a cabo conforme a las regulaciones nacionales en materia de construcción y cableado.

ČEŠTINA

Společnost Bowers & Wilkins nenese odpovědnost za škody či zranění vzniklé v důsledku nedostatečně bezpečné instalace. Instalace musí být provedena v souladu s vnitrostátními stavebními předpisy a předpisy vztahujícími se na elektrické instalace.

MAGYAR

A Bowers & Wilkins nem vállal felelősséget a bizonyítalan telepítésből eredő károkért vagy sérülésekért. A beszerelést a hatályos építési és kábelezési előírásoknak megfelelően kell elvégezni.

POLSKIE

Bowers & Wilkins nie będzie ponosić odpowiedzialności za jakiegokolwiek szkody lub obrażenia spowodowane niepewną instalacją. Instalacja musi być przeprowadzona zgodnie z krajowymi przepisami budowlanymi i elektrycznymi.

РУССКИЙ

Bowers & Wilkins не несет ответственности за любой ущерб или травмы, вызванные ненадежной установкой. Инсталляция должна выполняться в соответствии с национальными строительными нормами и нормами на монтаж и проводку.

日本

Bowers & Wilkinsは、不安定な設置によって生じた損害や傷害についての一切の責任を負いかねます。本機の設置は、国の建築基準法および電気設備技術基準に基づいて行ってください。

简体中文

Bowers & Wilkins 对因不安全的安装而造成的任何损坏或伤害概不负责。必须按照国家建筑和布线法规进行安装。

繁體中文

Bowers & Wilkins 對因不安全的安裝而造成的任何損壞或傷害概不負責。安裝必須按照國家建築和接線法規進行。

한국인

Bowers & Wilkins은 불안정한 설치로 인한 손상 또는 부상에 대한 책임을 지지 않습니다. 제품 설치 시 해당 국가에서 요구하는 건물 및 배선 규정을 준수해야 합니다.

1

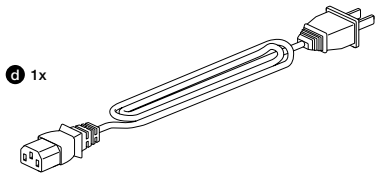
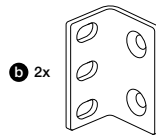
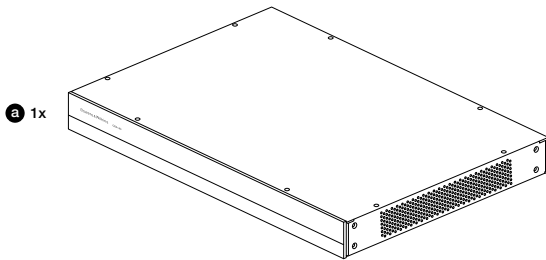

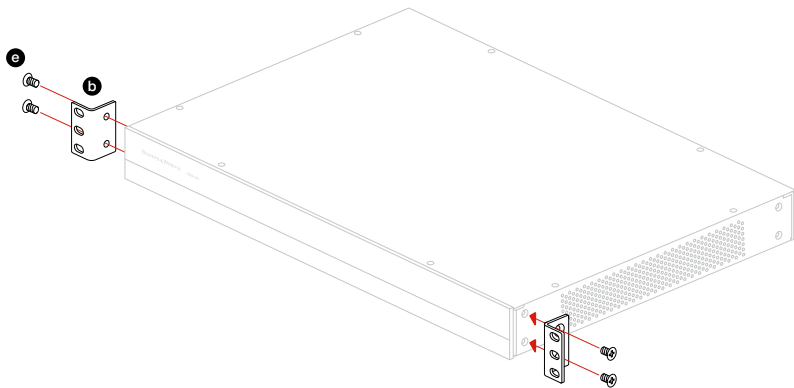
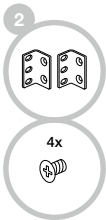

OR / OU

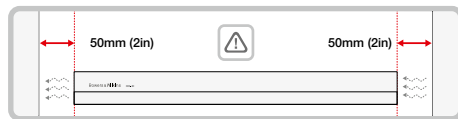
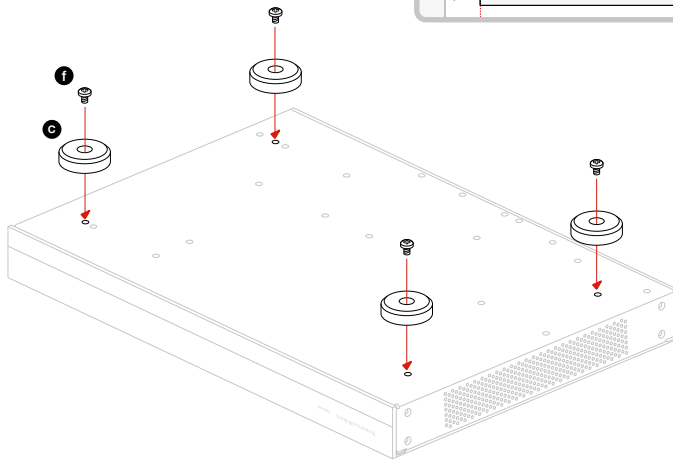

EN

An **Ethernet** connection is **mandatory** for setup and configuration.

FR

Une connexion **Ethernet** est **obligatoire** pour l'installation et la configuration.

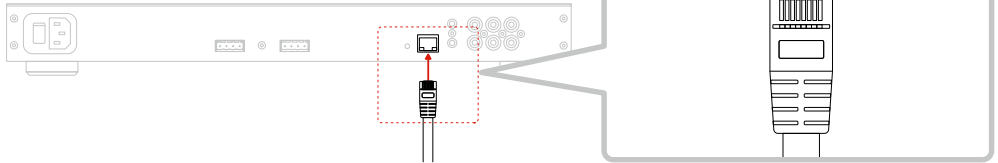

DE

Für die Einrichtung und Konfiguration ist eine **Ethernet-Verbindung** zwingend **erforderlich**.

ES

Para los procesos de configuración y ajuste es **obligatorio** disponer de una conexión **Ethernet**.

IT

An **Ethernet** connection is **mandatory** for setup and configuration.

RU

Ethernet-соединение **обязательно** для настройки и конфигурирования.

JA

セットアップおよび設定を行うには、**イーサネット接続が必要です**。

ZH

网络连接是设置和配置所必需的。

4 RCA

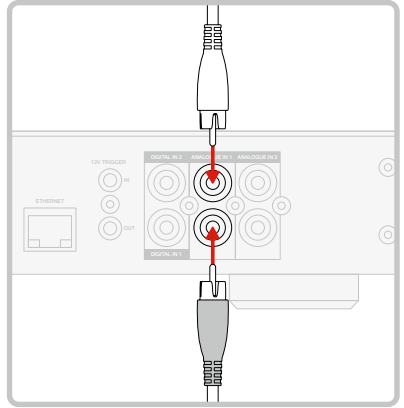

OR / OU

S/PDIF

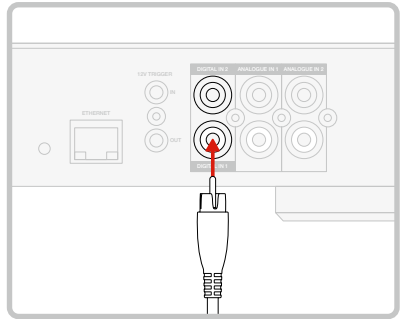

5

Standard Wiring

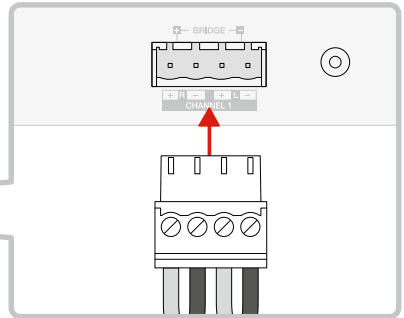
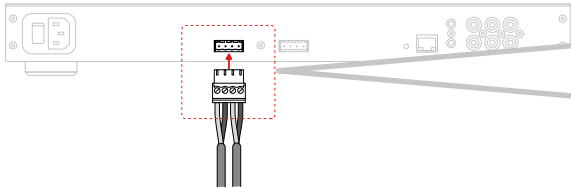
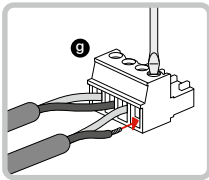

OR / OU

Bridge-Tied Load Wiring

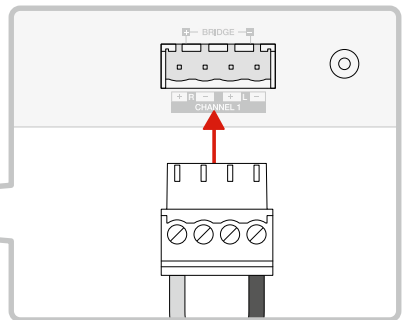
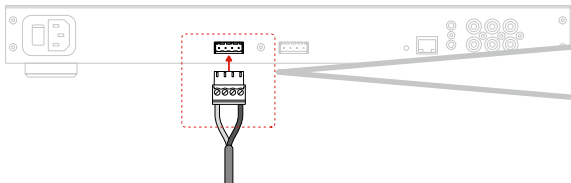
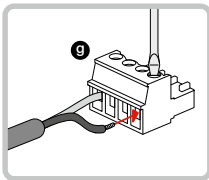

6a

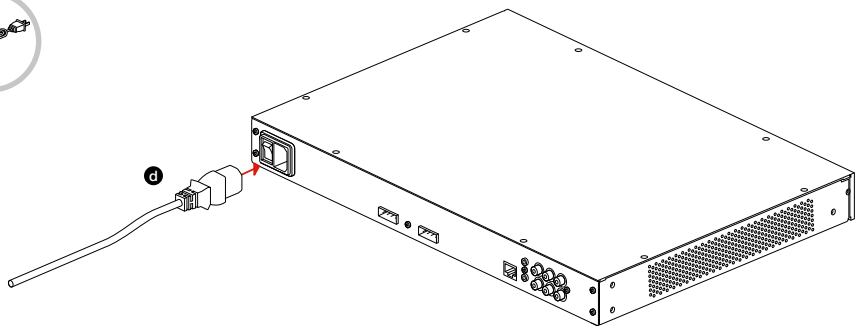

6b

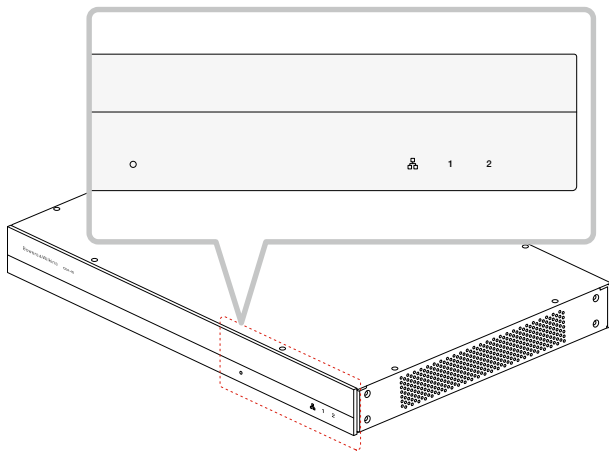

7a

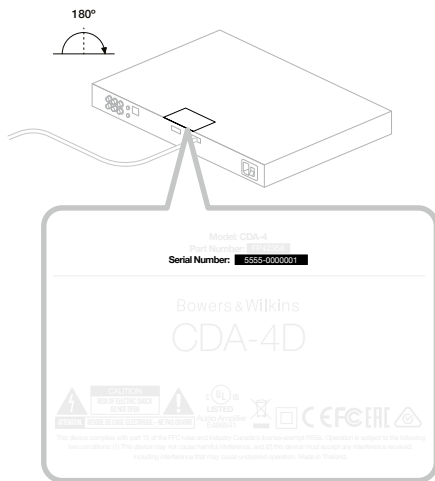

7b

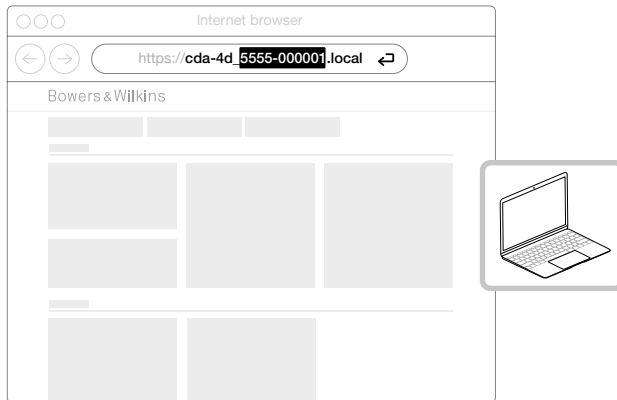

B&W Group Ltd.
Dale Road Worthing
West Sussex
BN11 2BH England

EU Importer:
Bowers & Wilkins
Beemdstraat 11
5653 MA Eindhoven
The Netherlands

Copyright © B&W Group Ltd. E&OE



Pour en savoir plus :
www.quefairedemesdechets.fr

